

19

20

21

22

23

24

25

26

27

28

Lipo Bay
Re-Enforced
Sides
3mm EPP x2

Fus
Bottom
Front
Spacer

Lipo Bay
Bottom Hatch

Fus Centre Crutch

Fus Upper
Former

Firewall
x2

Lower Wing Re-Enforcing Plate



With Servo Cutout



Fus Bottom Rear Spacer

Centre
Cabane
9mm EPP

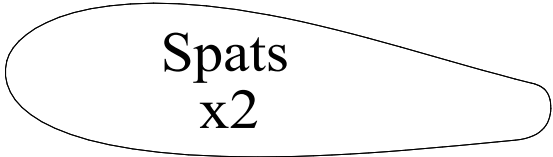

Fus Lower
Formers
x3

Notes:
Fuselage Side
All Other Part
Design: Dave
This copyright

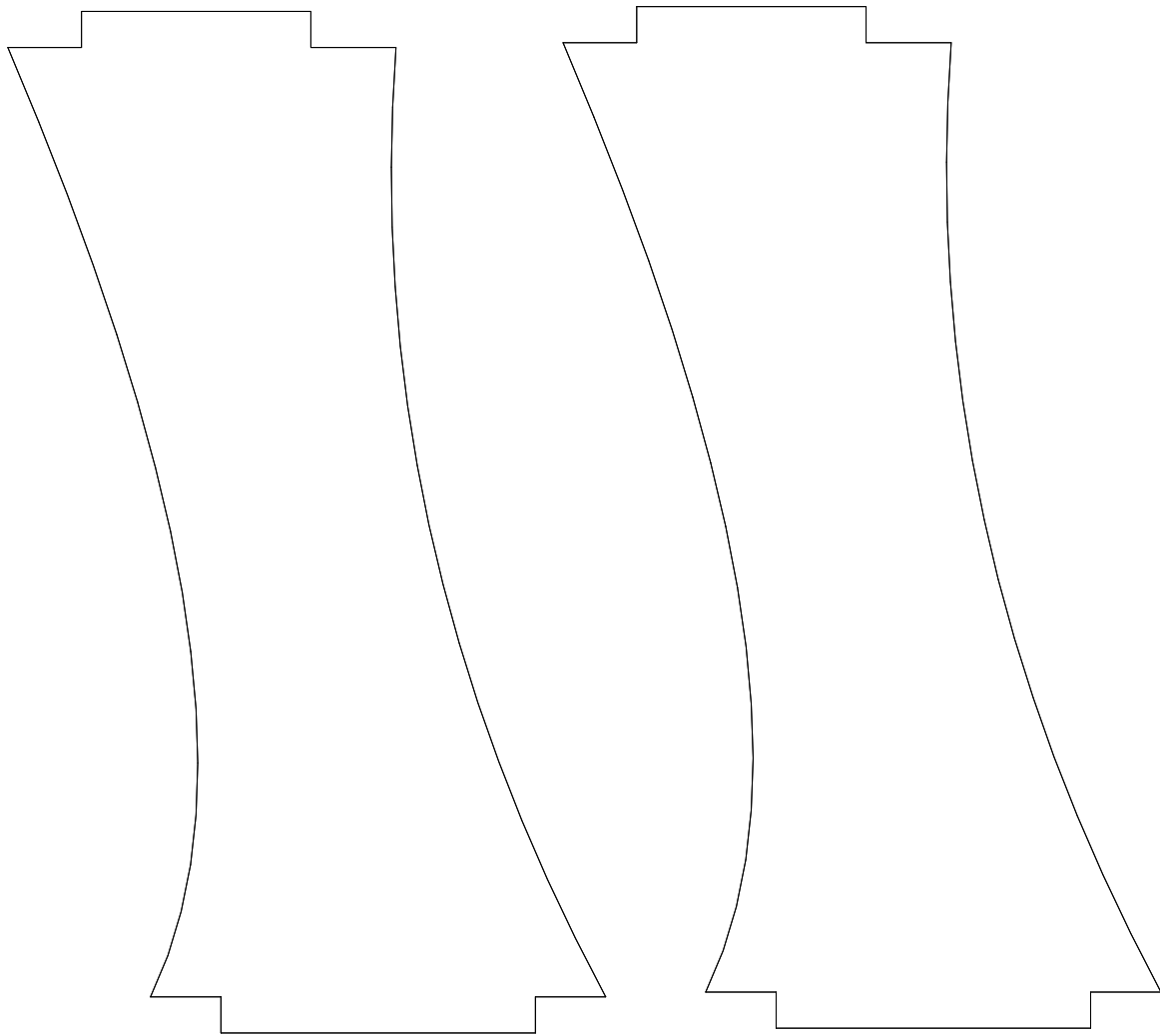

s Cut From 3mm EPP

s From 5mm or 6mm EPP Unless Otherwise Stated.

Royds Drawn By: Si Mills

protected plan is free for personal, non-commercial use only

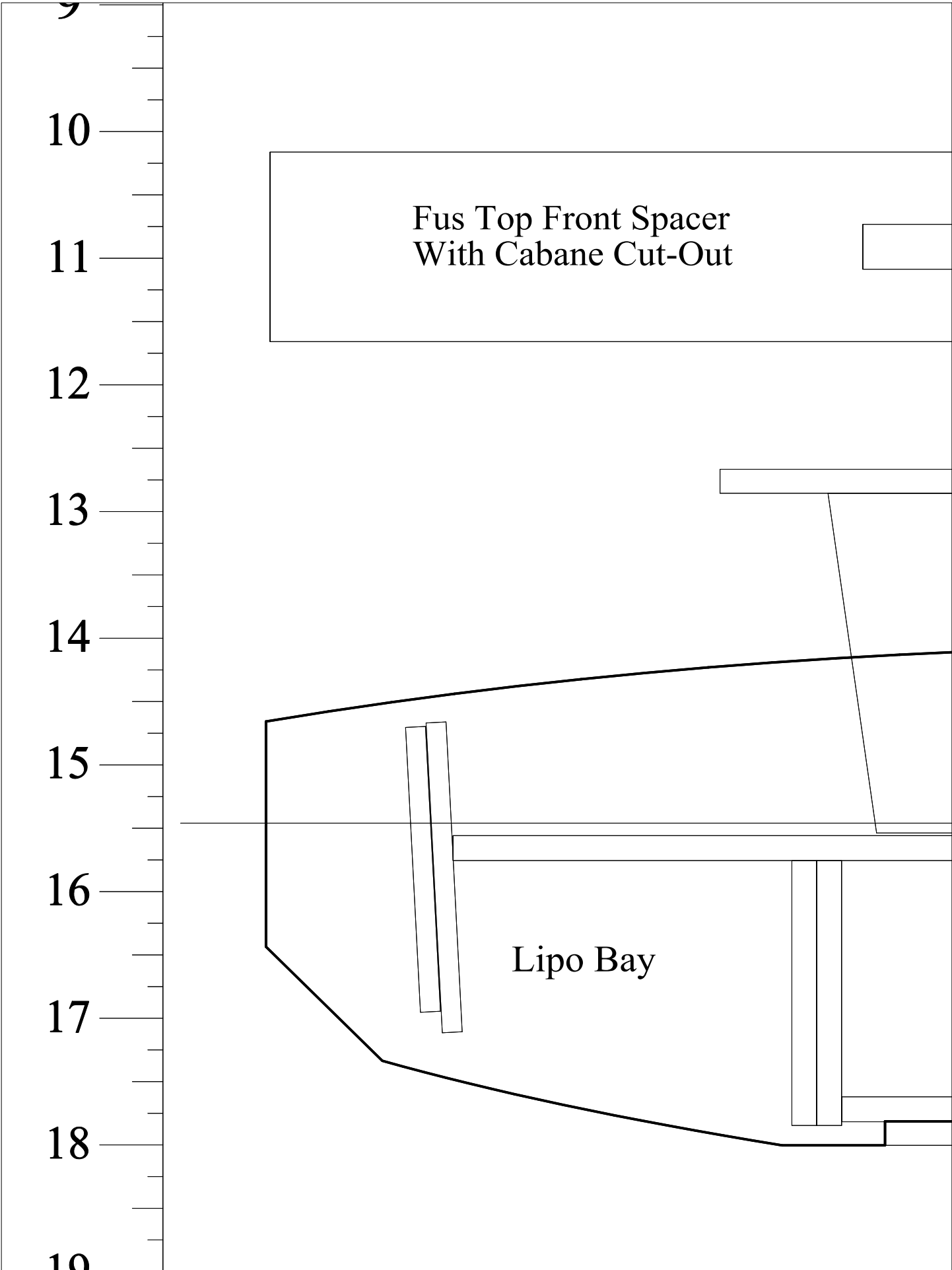

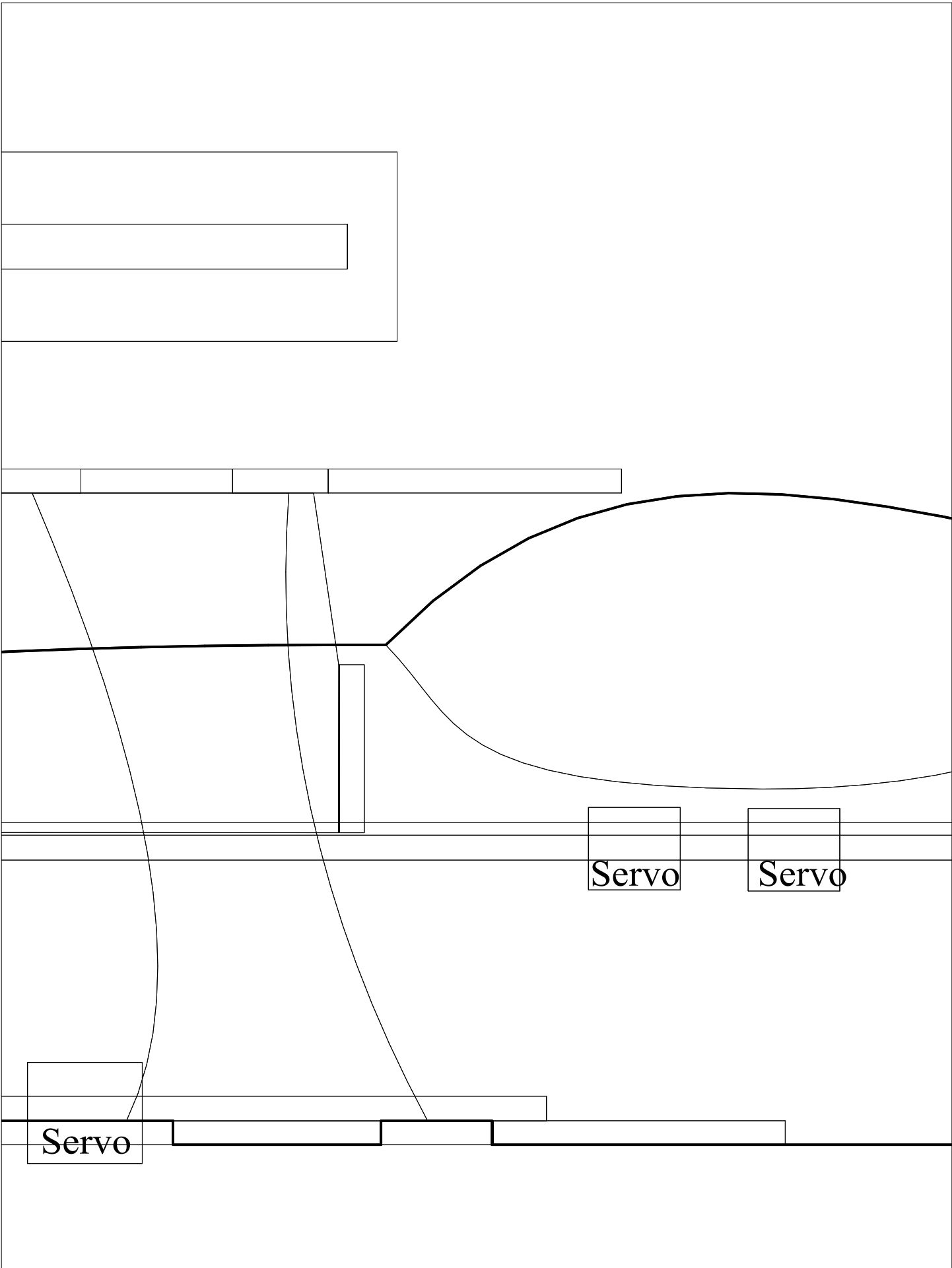

Canopy

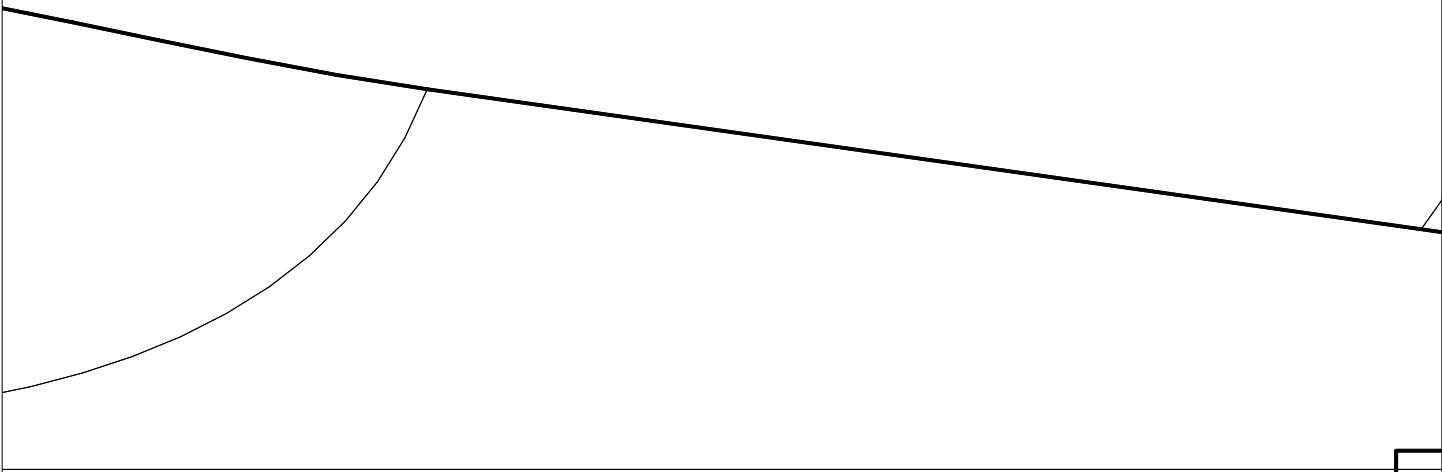

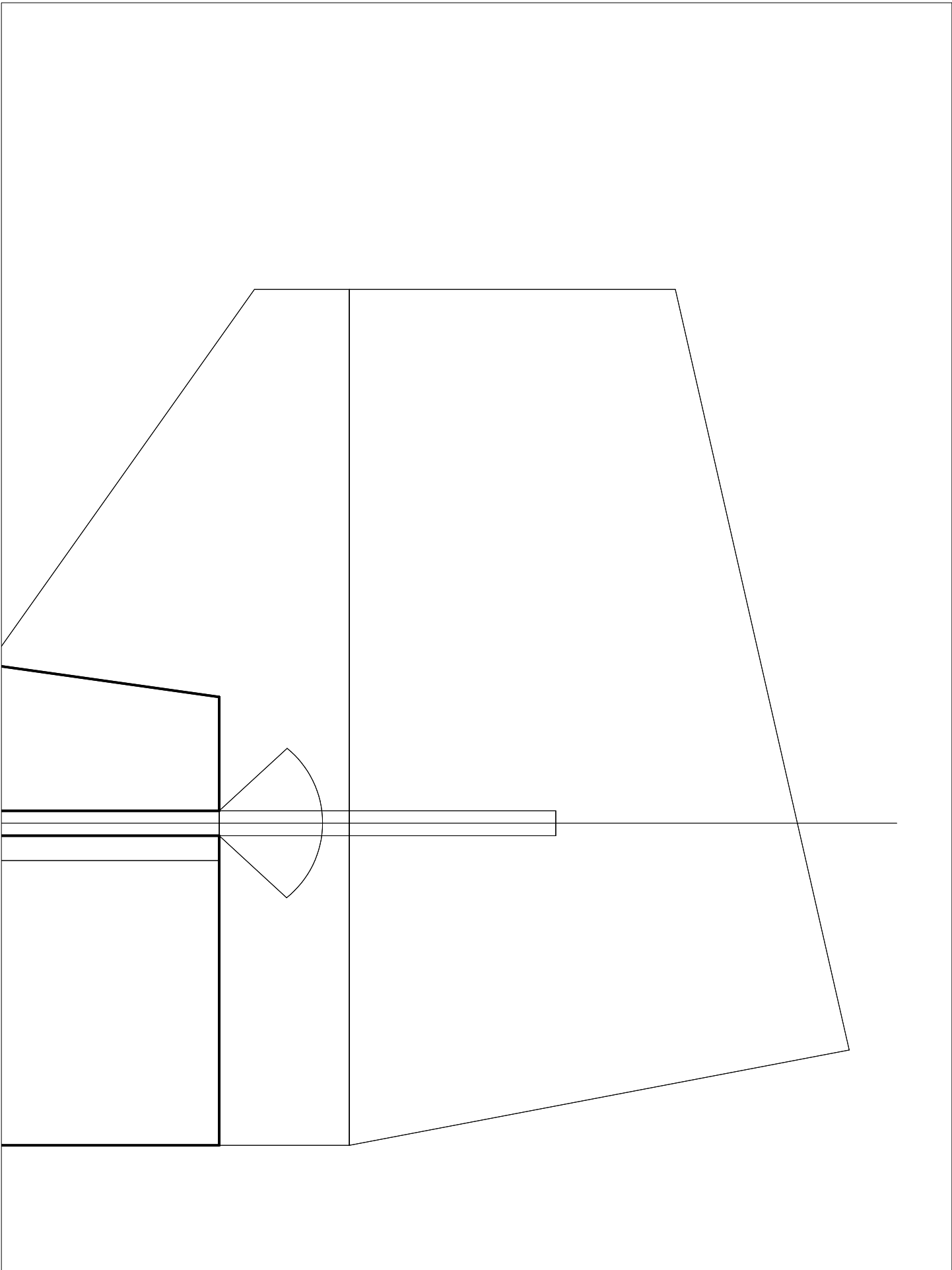

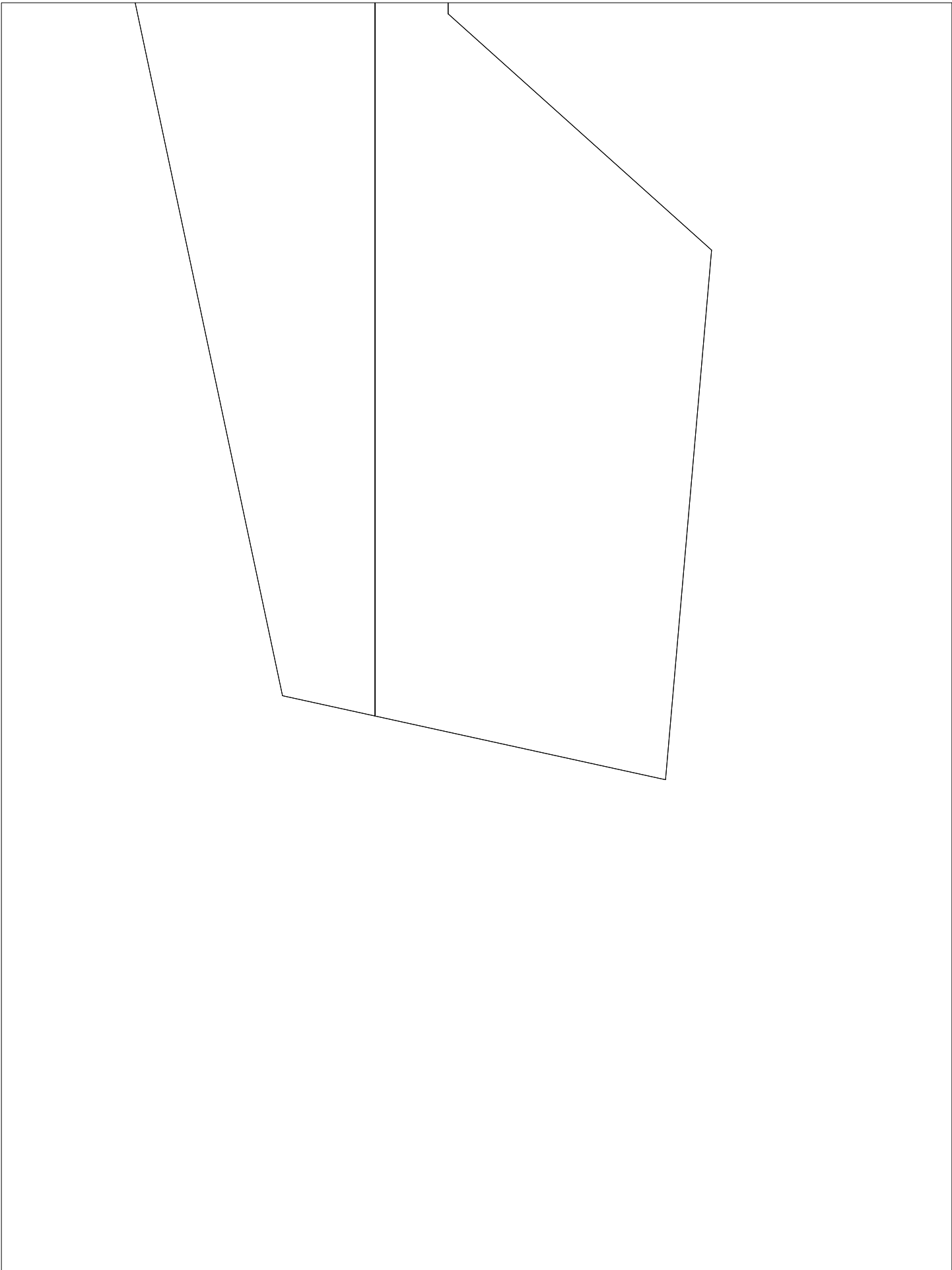

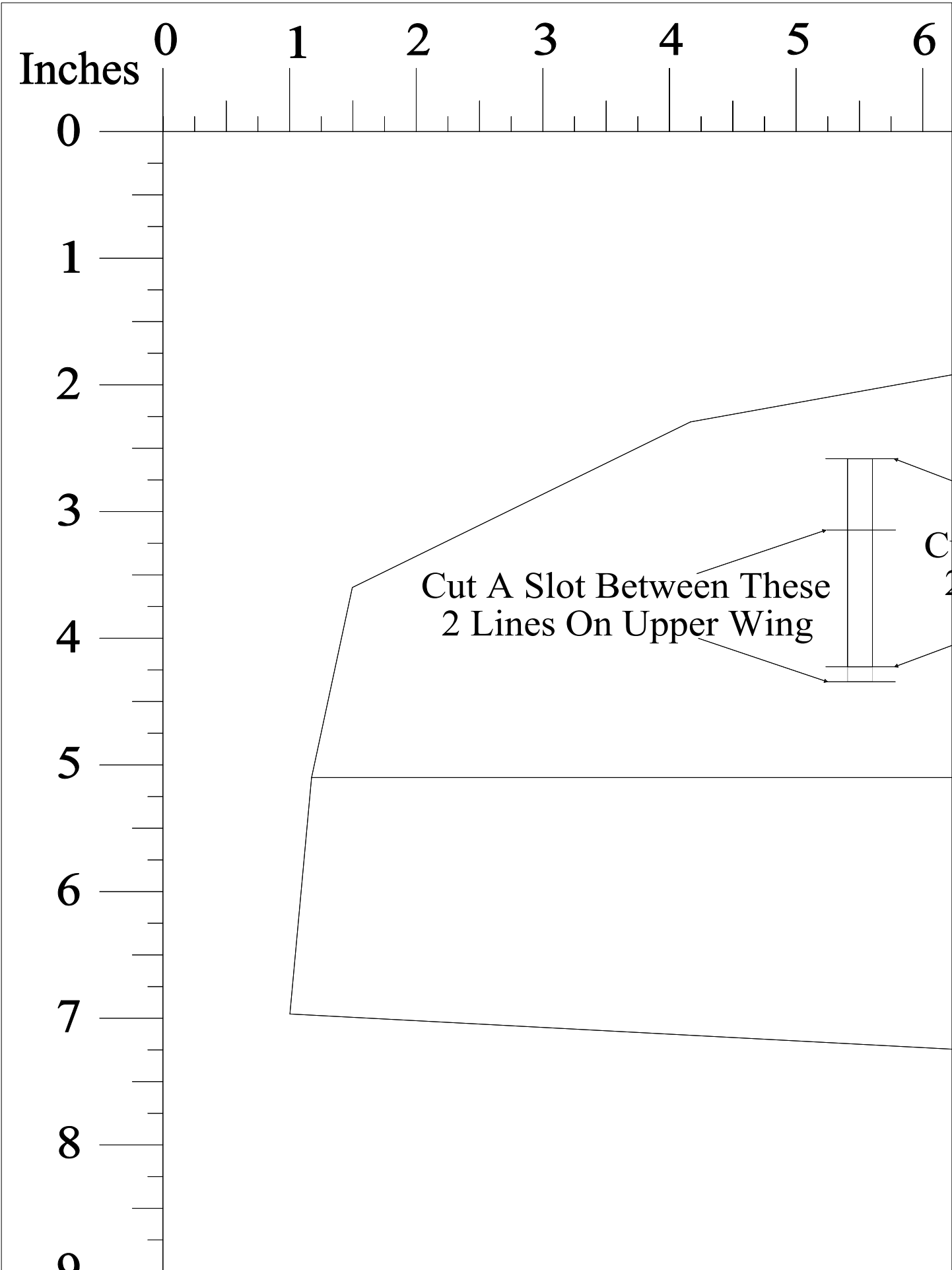

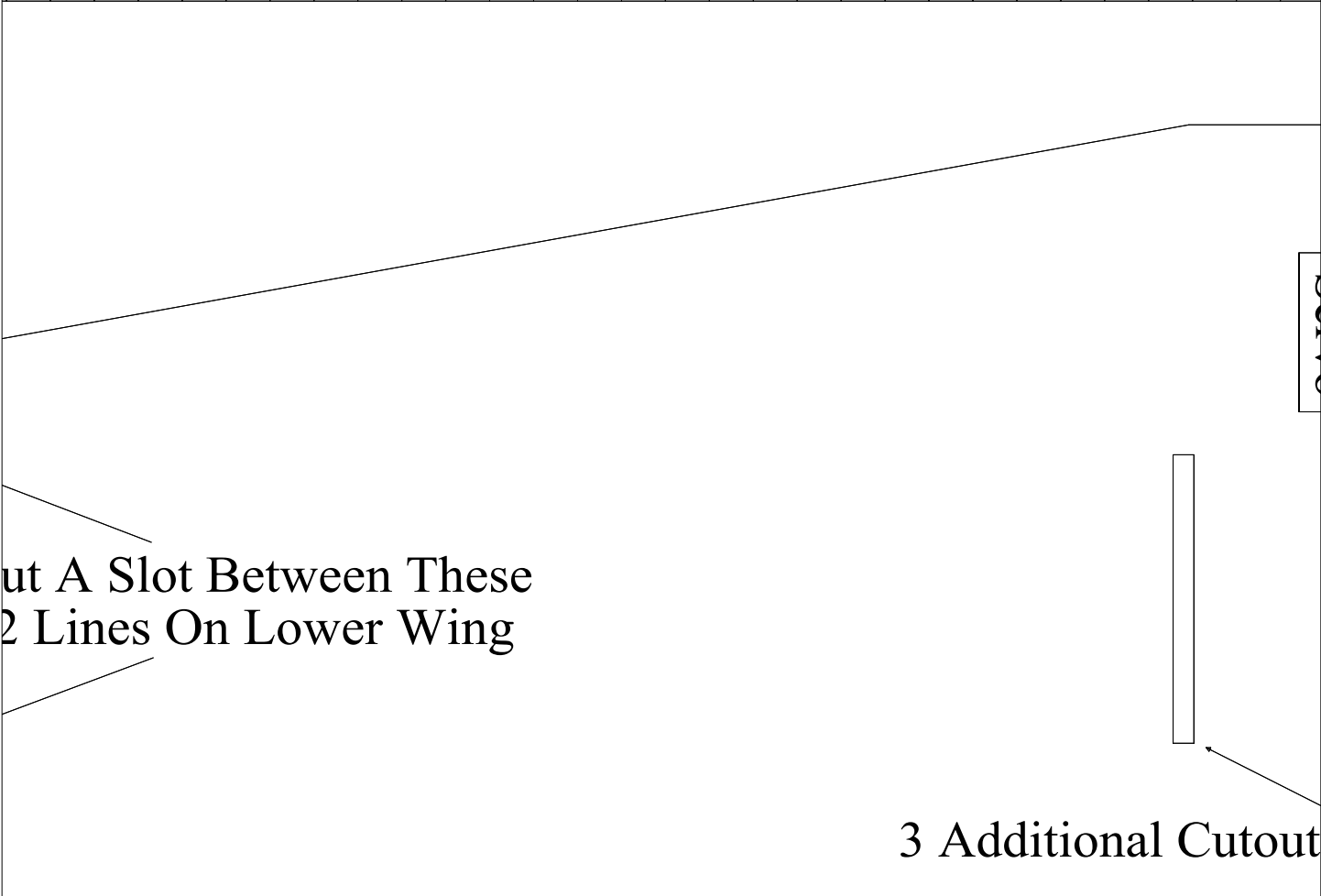
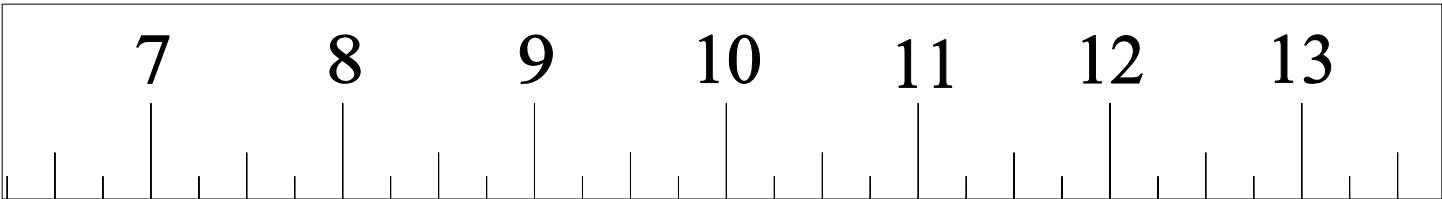

Cut A Slot Between These
2 Lines On Lower Wing

3 Additional Cutout



22

23

24

25

26

27

28

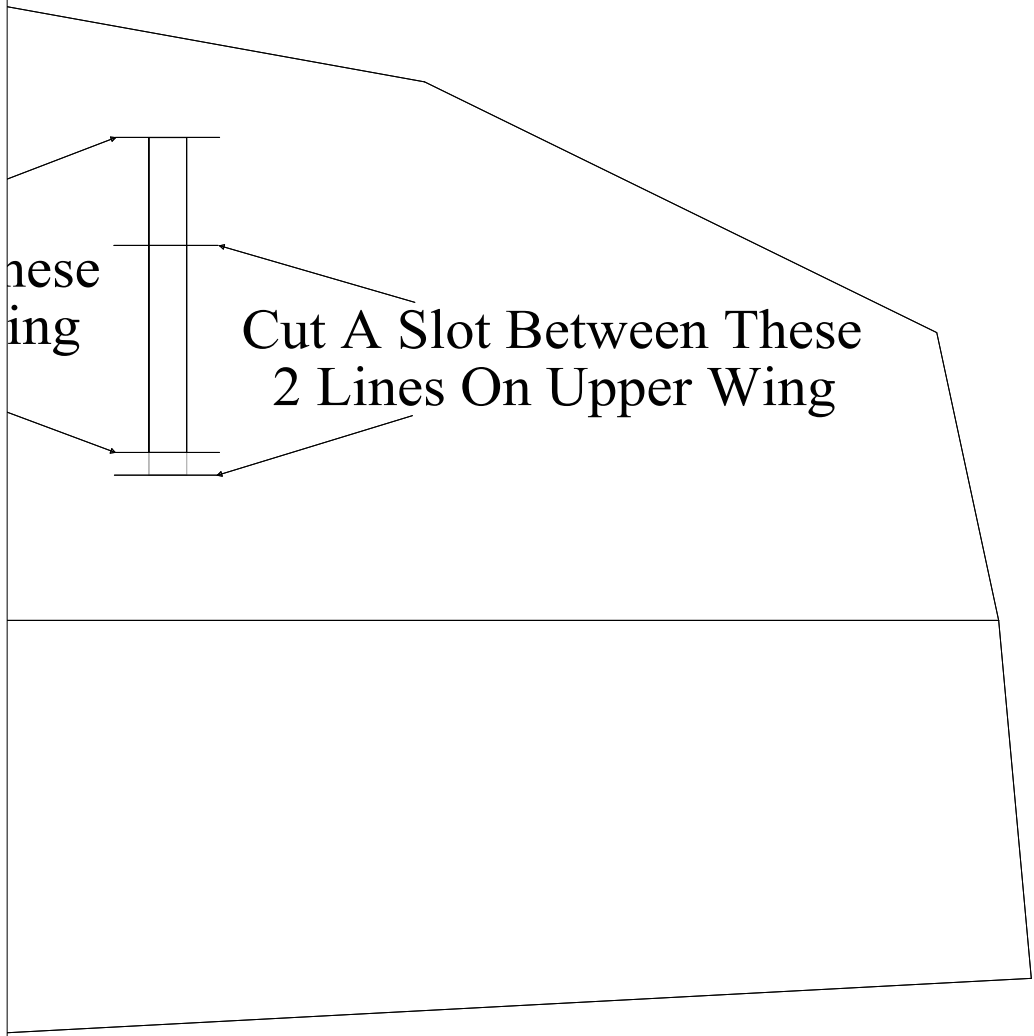

nose
ing

Cut A Slot Between These
2 Lines On Upper Wing

29

30

31

32

33

34

